

E-Lite

Cat. No. EAVE

Cat. No. EAVE105



The E-Lite is a recessed downlighter ideal for installation in eaves, soffits, entrance ways, verandahs, carports or covered decks. It can also be used in bathrooms, kitchens or where moisture transfer or decibel rating is a minimum requirement.

This luminaire is machined from a choice of 10mm thick aluminium with a UV stable powder coated finish, solid copper or 316 stainless steel with a clear, tempered, flush glass lens and high temperature silicon gaskets. The 316 stainless steel E-Lite is electro-polished to increase corrosion protection.

A 105mm version of the E-Lite is available and has been designed to fit a standard 90mm cut-out.

Ordering Information

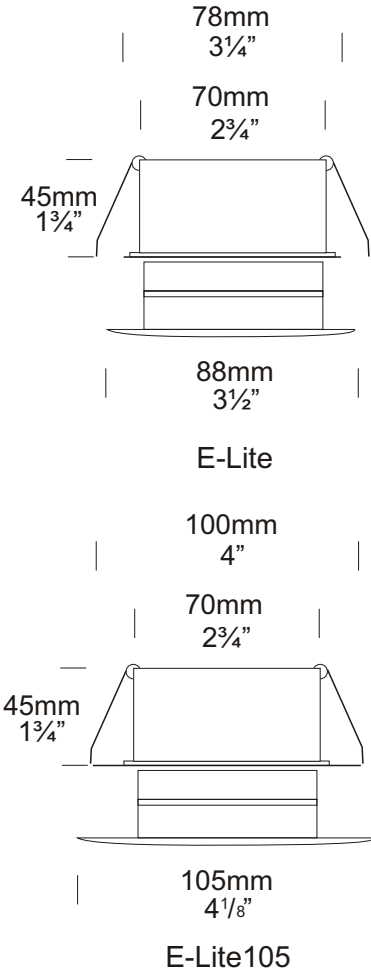

Luminaire Type	Material	Accessories
EAVE - E-Lite EAVE105 - E-Lite 105mm	BK - Black WH - White COP - Copper SS - 316 Stainless	CJK150 - Cable Joint Kit LENSSTEPF - Frost Lens For an alternative LED option start at page 10.4

Ordering Example: EAVE COP - E-Lite in Copper



E-Lite

HUNZA™ PURE OUTDOOR LIGHTING

HUNZA FACTORY
130 Felton Mathew Ave
Glen Innes
Auckland 1072
New Zealand

Ph: 64-9-528 9471
Fax: 64-9-528 9361
hunza@hunza.co.nz
www.hunza.co.nz

INTERNATIONAL CONTACTS:
www.hunza.co.nz/contacts.php

Specifications may change without notice.
Manufactured in New Zealand.

© 2009 Hunza Holdings Ltd.

Ver 1.4

Luminaire Construction

CNC machined from:

Aluminium body high corrosion resistant 88mm (3½"), or 105mm (4⅛") solid aluminium rod with chromate substrate and high UV resistant polyester powder coat.

Colours Black or White.

Copper body 88mm (3½"), or 105mm (4⅛").

316 Stainless Steel body 88mm (3½"), or 105mm (4⅛"). Electro-polished.

Canister 316 Stainless Steel

Mounting

Via canister supplied, which maintains the aesthetic look of the flange by eliminating any mounting holes in the flange. The E-Lite canister is designed to fit through a 70mm hole and be fixed into position by two spring clips. The luminaire is held in the canister by an O ring. The E-Lite105 canister has a larger flange (100mm) and has been designed to fill a 90mm hole.

The stainless steel E-Lite is electro-polished, this finish increases the protection against corrosion by up to 33%.

Features

Lens:

10mm (3/8") clear flush fit shatter resistant glass. A clear lens is fitted as standard.

Lamp Holders:

GU5.3 - 350°C (662°F) ceramic multi contact lamp holder with 250°C (480°F) teflon cables.

Accessories:

Cable Joint Kit (Cat. CJK150).
Frost Lens (Cat. LENSSTEPF).

Standards

IPX5

NZECP 54 = CA, SCB 100mm
HBX 75mm, REC 135mm
DB = RW30

Weight

E-Lite Alum .30 kg (11oz)
Cop .80 kg (1lb 12oz)
SS .75 kg (1lb 10oz)

E-Lite105 Alum .40 kg (14oz)
Cop .95 kg (2lb 2oz)
SS .90 kg (2lb)

Power Supply

HUNZA™ H20, H40 or H50
Transformer: not included.

Lamp Type

Suitable for use with Halogen
MR16 GU5.3 50 watt lamp max.

LED - Refer sheet no. 10.4

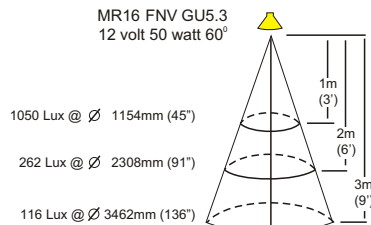
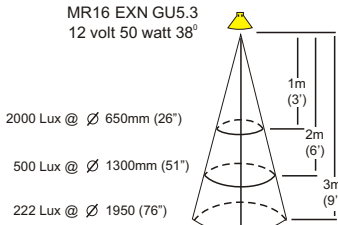
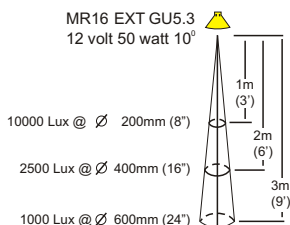
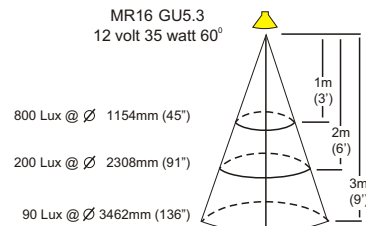
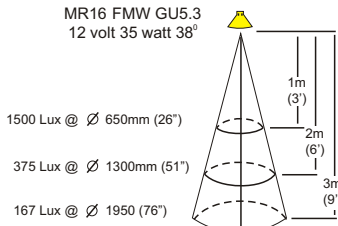
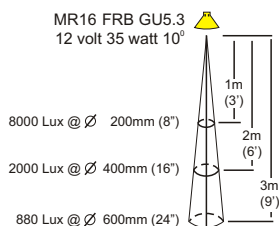
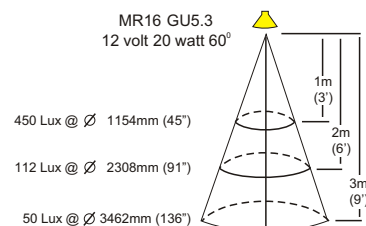
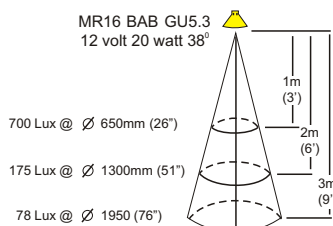
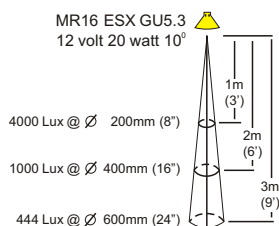

HUNZA™ PURE OUTDOOR LIGHTING

HUNZA FACTORY
130 Felton Mathew Ave
Glen Innes
Auckland 1072
New Zealand

Ph: 64-9-528 9471
Fax: 64-9-528 9361
hunza@hunza.co.nz
www.hunza.co.nz

INTERNATIONAL CONTACTS:
www.hunza.co.nz/contacts.php

Specifications may change without notice.
Manufactured in New Zealand.

© 2009 Hunza Holdings Ltd.

Ver 1.4