



SafeTouch™ 50

INSTALLATION INSTRUCTIONS

NOTE: THESE INSTRUCTIONS MUST NOT CONTRAVENE YOUR LOCAL ELECTRICAL AUTHORITY REGULATIONS, WITH WHICH ALL INSTRUCTIONS HERE IN MUST COMPLY. PLEASE KEEP INSTRUCTIONS FOR FUTURE REFERENCE.

Tested and approved to IP67 AS/NZS 60598.2.2 

Remove the complete fixture from the packaging. If the canister and luminaire are to be installed separately detach the luminaire from the canister and place it back in the packaging and store securely. If not discard the packing in an environmentally friendly way. Dig a hole 25cm (10") diameter and 40cm (16") deep. Place drainage material in the bottom of the hole to drain away water and stop water level build up. (See Fig. 1).

Sit mounting canister into the hole. Make sure that the top of the canister is flush and level with the finished floor or ground level (see Fig. 2).

Take care not to disturb the spring loaded heat transfer clamps (see Fig. 4).

Draw the power supply cable up through the centre of the canister ready for connection to the luminaire.

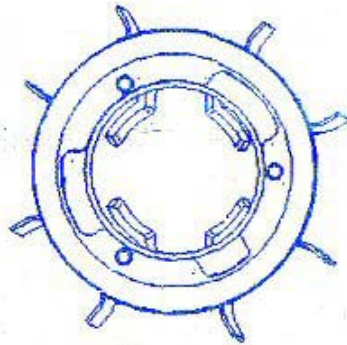

Fig. 4

Place blue flange protector (see Fig.3) into the top of the canister and press firmly into place. This will protect the bronze or stainless steel flange as well as stopping debris filling the canister. If grout is to be used with tiles etc. then remove the flange protector before grouting is started. The canister fins have been recessed for use with up to 60mm (2 1/2") paving or cobble stones. Backfill the hole around the canister with soil or concrete. If soil is used it should be compacted to facilitate better heat transference into the ground.

NOTE: Do not backfill with stones, scoria or any material that will leave air gaps next to the canister. Concrete is strongly recommended to backfill the canister hole. Concrete will conduct away 40% more heat than soil.

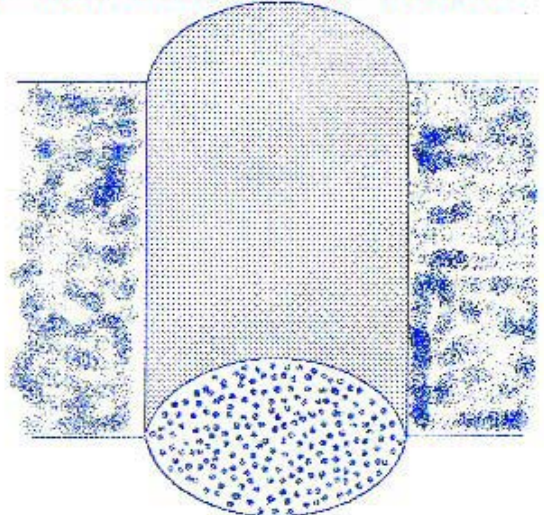

Fig. 1

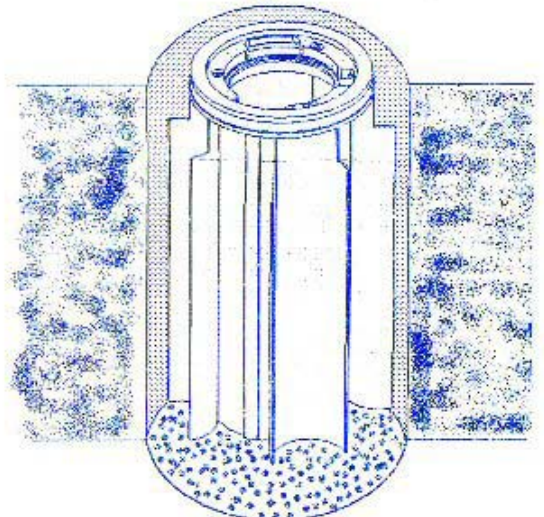

Fig. 2

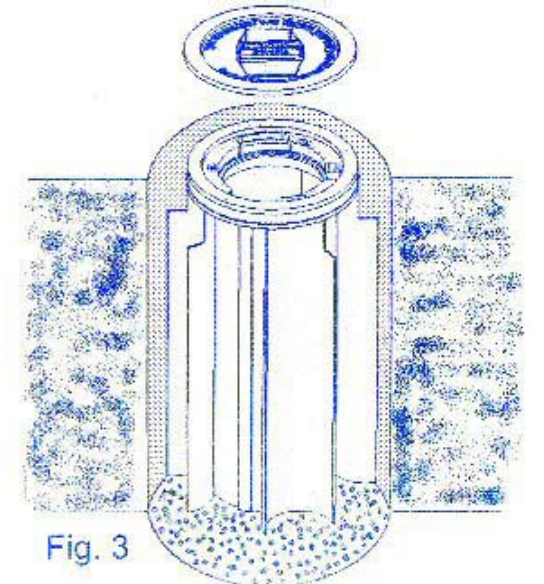

Fig. 3

Once ground works are complete remove the blue flange protector. Draw supply cable through canister and make a waterproof connection to the luminaire input cable. (See Fig.4a)

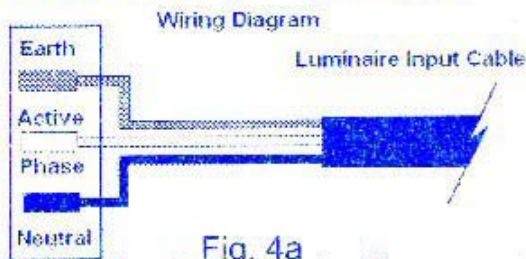

Fig. 4a

NOTE: This luminaire must not be connected to a home automation system due to the electronic ballast. Connect home automation system to a mechanical relay to switch the luminaire.

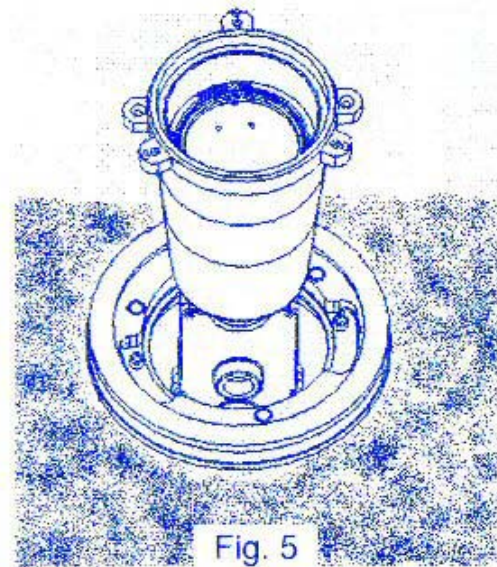

Fig. 5

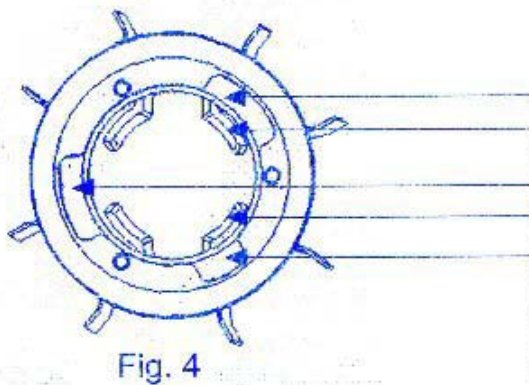

Fig. 4

Place the luminaire into the canister (see Fig.5) taking care not to displace the heat transfer clamps with the Luminaire cables. (See Fig. 4).

NOTE: Make certain that the heat transfer clamps and the flange surfaces are clean - dirt sand and mud free.

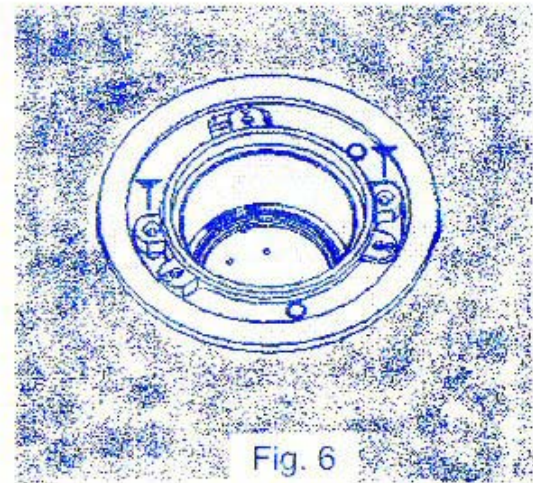

Fig. 6

Tighten the two screws provided that hold the luminaire into the canister by hand only -- no power tools should be used on this luminaire. (See Fig. 6).

Make sure debris does not fall into the open luminaire while working.

Remove desiccant sachet from sealed bag. Lift gimbal assembly out of lamp housing. Slide under sachet clip at the bottom of the lamp housing. Make sure the desiccant bag is not torn. Refit gimbal assembly back into lamp housing. (See Fig. 6a).

NOTE: This should be done as close as possible to the time the luminaire is to be sealed up. If the desiccant is left too long in an open luminaire it will not be able to function correctly.

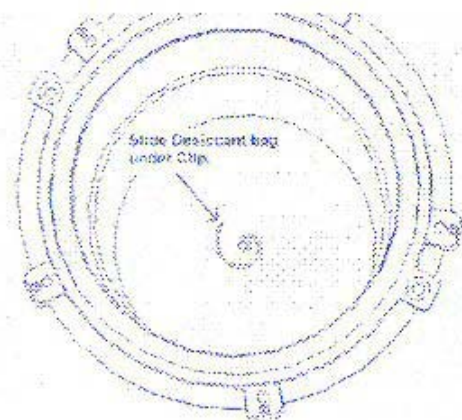
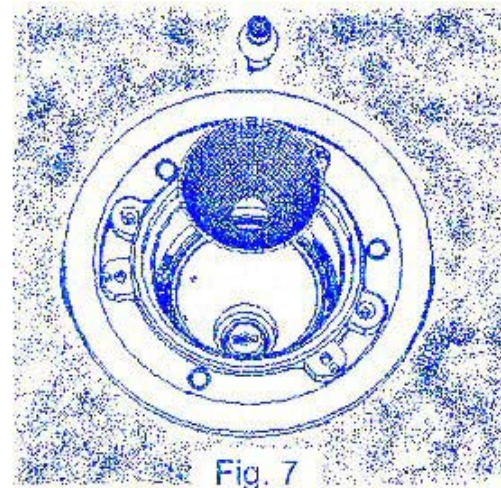
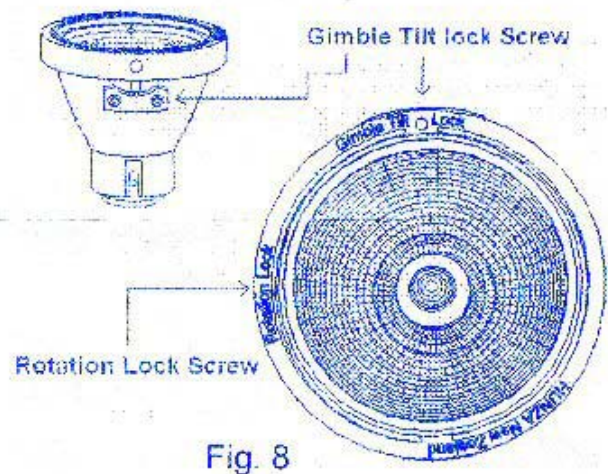

Fig. 6a

Place reflector into position in the Gimble and fit lamp into lamp holder. Take care not to touch lamp with bare fingers. (See Fig. 7)



Adjust both Rotational and Tilt angles to desired position with an allen key and tighten grub screws to lock settings in place. (See Fig. 8)



NOTE: Do not touch Heat Filters in the Baffle assembly with fingers.

If a Hex Cell Louver or Colour Filter is to be installed fit to the Optics Holder before securing on top of reflector in the gimble assembly. (See internal sticker for assembly sequence). If there is no Hex Cell Louver or Colour Filter to be fitted then place the Optics Holder directly on top of the reflector. (See Fig. 9)

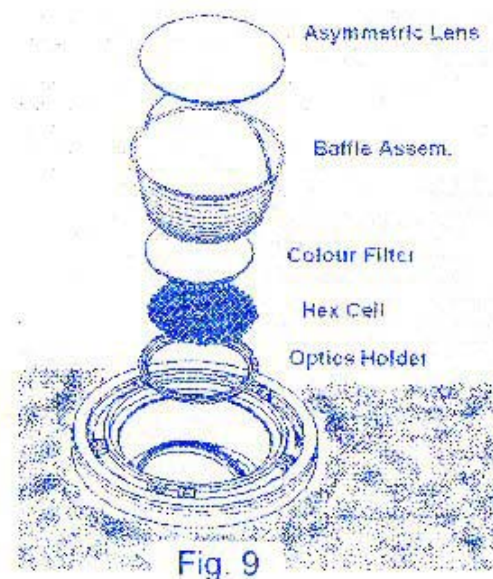

The Asymmetric Lens is placed on top of the Heat Filter of the Baffle assembly. If no Heat Filters are fitted then place the Asymmetric Lens into the Baffle and fit into groove provided. Rotate the Baffle assembly to the desired position and fold handle down flat.

(See Fig. 9 and 9a)

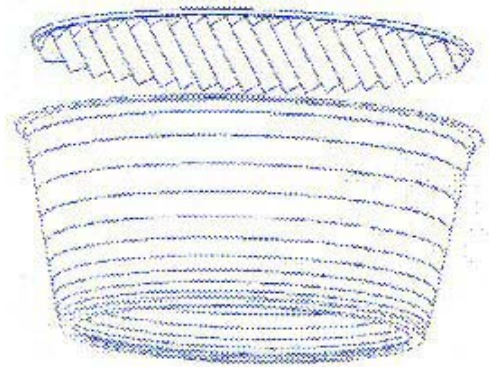

Fig. 9a

NOTE: Before installing the gasket and flange – test the luminaire for 10 minutes to dry out the desiccant sachet which will stop moisture build up on the lens. After the warm up period then begin installation of lens and flange.

Be certain to clean gasket recess before placing Lens and Gasket assembly into the gasket recess in the luminaire (see Fig. 10).

Make sure that the lens and gasket are clean.

Place Flange on top of gasket and lens assembly and tighten the three screws evenly. (See Fig. 11).

NOTE: To avoid potential unsafe lamp failure, the luminaire should be switched off at least once a week.

If the external flexible cord of this luminaire is damaged, it shall be replaced by a special cord exclusively available from the manufacturer or his service agent.

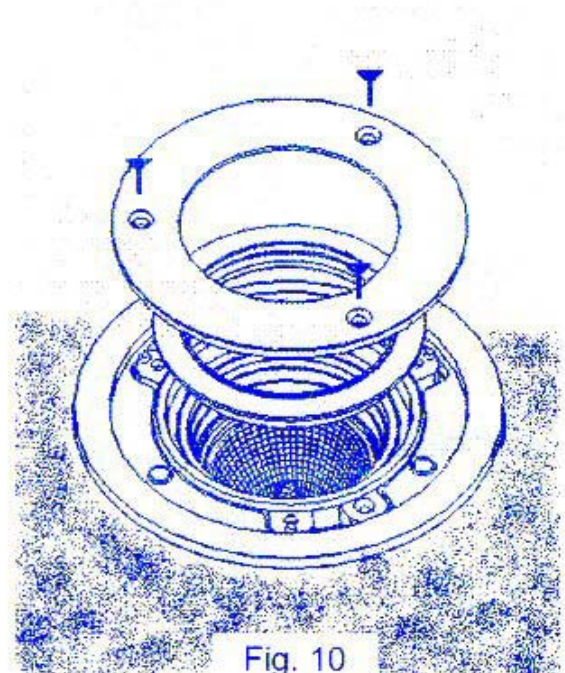

Fig. 10

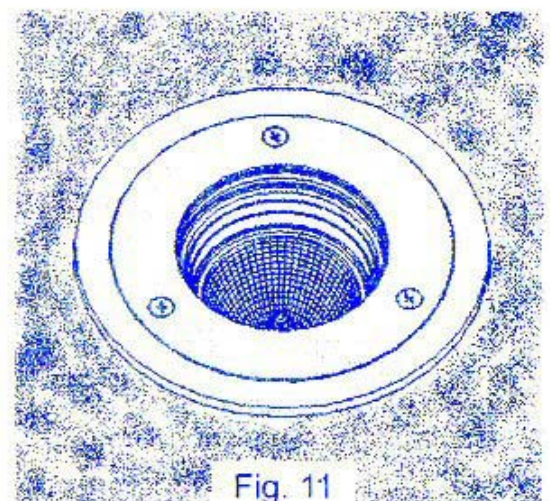

Fig. 11

Made In New Zealand

www.hunza.co.nz